

that the coupled external resonator affects the internal energy of the water resonance in such a way as to be measurable by the microcalorimetry technique. This is likely to be a quantum field interaction as suggested above. An analogy would be the coupling within a laser cavity, but in the case that water coherence already exists, no pumping is necessary.

The equations for an RCL resonant circuit can be written with the magnetic vector potential replacing the current and give the same conditions of resonance. The frequency information imprinted into water by a magnetic field is the frequency of the magnetic vector potential component \underline{A} ^[6]. The \underline{B} component merely enables this imprinting.

As a classical approximation to a quantum mechanism, consider thermal agitation inducing random currents in a RCL circuit and hence random \underline{A} fluctuations. Within a resonance, these are magnified by the “ Q ” factor of the circuit. This may bring them above the threshold necessary to imprint the water. To test this, a CL circuit was tuned to 384 MHz and a tube of water was placed inside the coil. After about 130 seconds, this frequency had become imprinted into the water. To determine the threshold “ Q ” factor, series resistors were added in sequence until the water failed to take up that frequency. This occurred with 3 ohms. With 2.5 ohms there was still a frequency imprint. Thus, the threshold for imprinting water was $392 < Q < 470$. Thermal electrons have an energy of 1/40 eV; with 2.5 ohms this would represent 10 mA. At resonance, the interchange of thermally excited volt-amps-reactive between L and C would pass through the 2.5 ohms in a coherent manner and be multiplied by the “ Q ” factor giving 4.7 A and a magnetic field in the coil of $B = 634 \mu\text{T}$ which is about the threshold \underline{B} field needed for imprinting the frequency of the \underline{A} component into water^[6]. When there is a voltage across the resistance, there must be no current through it and vice-versa, otherwise there would be power dissipation, which clearly is not happening.

Final remarks

Our experiments have proved that exposing water to passive RCL circuits can permanently alter some of its physico-chemical properties. Moreover, the water sample after exposure acquires a “biological-like” behavior that lasts for a significant interval of time. We can reasonably assume that such a behavior will somehow affect any chemical and/or bio-chemical reactions in which the exposed water may become involved.

It is important to realize that one is not accustomed to discussing the physics of water used as a solvent. In other words, most of the time the experimenter is concerned only with checking the chemical purity of the water needed. Now, we know that some message could have already been “written” into the water sample without altering its chemical purity in any way. That “hidden message” could be the cause of a constructive or a destructive interference with any “new message” the water sample may be about to receive.

The chemical message (signature) may of course be much more “powerful”

than the physical one, at least at short ranges of the order of the chemical bond length, and thus be little affected by it. Suppose we are working at a level where low intensity actions possibly at long range are significant, such as for instance at the homeopathic level where such changes could make a great difference. That is to say, until now we have overlooked the importance of the solvent in homeopathic preparation. The effectiveness of homeopathic remedies might largely depend on the physical treatment the solvent water has undergone before its use for homeopathic preparation. Further studies on this subject are in progress.

Acknowledgement

Claudio Cardella wishes to express his gratitude to Prof. R. S. Sansevero for his benevolent attention throughout the development of this study.

Notes

¹If the frequency resonances are stored “delocalized”, as hologram, it would be necessary to provide a “reference beam” or equivalent to localize the information in space and time. This might have been the function of the tracking oscillator.

²Water imprinted with frequencies by the methods used by C.W. Smith^[11] gave qualitatively similar microcalorimetric results when tested by Prof. V. Elia.

³It may be worth noting that the term “Water Memory” was introduced for the first time in 1978 by C. Cardella and Fulvio Di Pascale^[18]. The work remained unpublished for a long time, and it was later reviewed by Linus Pauling, who, in a private communication to C. Cardella of January 15, 1982, wrote “I doubt that water is endowed with a memory until the liquid is biologically active...” thus indirectly substantiating the claim.

References

1. Elia, V. (1997, September). *Thermodynamics of extremely diluted solutions. A calorimetric study at 25°C*. Paper presented at OMEOMED, 1st World Conference, Urbino, Italy.
2. Elia, V., & Niccoli, M. (1999). Thermodynamics of extremely diluted aqueous solutions. *Annals of the New York Academy of Sciences*, 879, 241–248.
3. Cardella, C. (1995, July 11–13). *Morphology and self-organizing systems*. Paper presented at ISAGA-CAO Conference, The Challenge of Change: Learning to cope with (self)organizing systems, Palma de Maijorca, Spain.
4. Smith, C. W. (1994). Biological effects of weak e.m. fields. In Ho, M-W., Popp, F-A., & Warnke, U. (Eds.), *Bio-Electrodynamics and Bio-Communication* (pp. 81–107). Singapore: World Scientific.
5. Smith, C. W. (1999, December 10). *Frequency and coherence in water and living systems*. Paper presented at the First International Workshop on the “Hidden” Properties of Water, 2nd University of Naples, Italy.
6. Smith, C. W. (1994). Electromagnetic and magnetic vector potential bio-information and water. In Endler, P.C., & Schulte, J. (Eds.), *Ultra High Dilution* (pp. 187–201). Dordrecht: Kluwer.

ing a deep breath the movement of the diaphragm induces an inertial weight gain, which is immediately compensated by a corresponding weight loss in accordance with Newton's Law. At the moment of death in the sheep NO compensating loss is observed and this is what makes the observed weight gain transients of such interest and if verified would be a truly reproducible anomalous phenomena.

Lew Hollander

Resonant Circuits and Properties of Water

I found the article "Permanent changes in the physico-chemical properties of water following exposure to resonant circuits" by C. Cardella et al. (in *JSE* 15(4), 2001) interesting not for the suggested physics of water memory but because the applied physico-chemical methodology may reveal a much deeper physical reality.

The authors found that exposure of bi-distilled water samples to a passive resonant circuit permanently affects water, causing changes in the heat of dissolution of NaOH and HCl measured in a microcalorimeter and pH, that the results of measurements are reproducible, although not quantitatively, and that during storage of the previously "irradiated" samples the measured parameters tend to increase.

Assuming that changes in the heat of dissolution and pH values were measured reliably and the readings were far beyond standard deviations (metrological details could be more explicit), I suggest to extend this experiment in view of what I call Speransky's Effect.

In the mid 70s Dr. S. V. Speransky, toxicologist with the Novosibirsk Institute of Hygiene, USSR, conducting experiments on mice observed what seemed to be distant communication between mice separated after belonging to a settled "social group." In his experiments two comparable groups of 20 mice (primary groups) were held in isolated containers for 10 days to establish social bonds between individuals. Then 10 mice were taken from each primary group, put together and fed without limitation. Remaining 10 mice from one primary group were fed without limitation while those from another primary group were starved. The hypothesis was that if distant communication between members of the primary groups exists, those "friends of the hungry" would eat more and gain more weight. And this was exactly what had happened: the difference in weight between two subgroups in the combined group was in tens of grams during the first 2-3 weeks¹. According to Dr. Speransky, three independent laboratories repeated the experiment with the same results. Neither iron screening of the combined group nor increased distance between "former friends" changed the effect, although the latter decreased in time.

Some three years after the beginning, on someone's suggestion, the experiment was performed with the experimenter blinded regarding which remote

group is fed and which starved. And the difference in the weight gain totally disappeared. It became clear that the effect was caused by the experimenter's expectation and this is what I called Speransky's Effect in my taxonomy of alternative medicine².

I am suggesting that the authors to check out the hypothesis that the observed physico-chemical effects in water are caused by the experimenters' expectations while the resonant circuits and procedures are just symbols enforcing their subconscious "emotional bond" with the subject substance i.e., to repeat the same experiments being blinded with respect to test and control samples. If this hypothesis is correct and Speransky's Effect can be extrapolated on chemical substances like water, this would support other paradoxical scientific observations such as W. Tiller's et al. effect of an "imprinted intent" on pH in water³, the "miraculous" effects of Olga Worrell on poisoned bacterial cultures⁴, Sun Chu-lin's acceleration of plants development⁵, Thomaz Green's acceleration of embryonic development of chicks⁶ and others.

References

1. Speransky, S. V. (1990). Experiments on human-animal biological communication. In *Proceedings of the All-Union Seminar "Informational Interactions in Biology"* (p. 53). Tbilisy.
2. Savva, S. (1998). The concept of MISAHA—The latest lesson and the next step. *Townsend Letter for Doctors and Patients*, 175/176, 94-98.
3. Dibble, W., & Tiller, W. (1999). Electronic device-mediated pH changes in water. *Journal of Scientific Exploration*, 13, 155-176.
4. Rubik, B. (1996). Volitional effects of healers on a bacterial system. In Rubik, B. (Ed.), *Life at the Edge of Science* (pp. 99-117). Philadelphia: Institute for Frontier Science.
5. Savva, S. (2000). Ms. Sun Chu-lin—The Outstanding gift to be studied. *Monterey Institute for the Study of Alternative Healing Arts Newsletter*, 28-29, 9-13.
6. Pulos, L., & Richman, G. (1990). *Miracles and Other Realities*. Omega Press.

Savely Savva

Monterey Institute for the Study of Alternative Healing Arts (MISAHA)

3855 Via Nona Marie, Ste. 102-C

Carmel, CA 93923

831-622-7975

e-mail: misaha@aol.com

Author's Response:

Regarding the metrological details Mr. Savva asks for, we clearly stated that the measurements of *Max excess heat* reported in Table 1 were automatically obtained through the microcalorimetric apparatus by subtracting from each reading its own control value (i.e. its blank). Thus, each specimen was its own control.

On the premise, if necessary, that the observed excess heat and the pH changes did exist, I agree with the remark that a deeper physical reality may reveal in the experiments. This is true in the case where a "Speransky's Effect" is not involved in the experiments, and it is even truer in the case that it is.

To outline my point of view, let us first assume that a Speransky's Effect is not involved in the experiments. Then, as we suggested, the energy needed to change the properties of the water samples might either be found in the geomagnetic field, or in some electromagnetic wave present in the environment. In both cases, a problem arises with the Conservation of Energy Principle, and eventually with the Second Principle of Thermodynamics. In the sense that an inconsistency seems to occur between the quantity (unobservable) of the cause and the quantity (observable) of the effect produced by such a cause. Besides that, there is a reversed time arrow with which to deal. As a conclusion, the actual scientific paradigm appears at discomfort to cope with these events.

Suppose now that a Speransky's Effect is actually involved in the experiments. If so, we are dealing with living systems. Then we have to acknowledge that the actual Physics and Chemistry can not handle living systems, as they correctly apply only to "closed" systems. A living organism is unable to survive in a closed (control) volume. If an "emotional bond" can now be established between the experimenters and the subject substance, this means that the subject substance itself has an "emotionally-sensitive" attitude. Here, the energy transfer from the experimenters to the subject substance leads to the existence of a physical field through which that exchange takes place.

Thus, the resonant circuit acts as the receiver, through the establishment of a suitable field, of some "mental energy", and subsequently as its transformer into the thermodynamic energy that changes the water sample properties. Alternately, we might suppose, as Mr. Savva hints, the resonant circuit and the other procedures are just symbols. This eventuality is far more intricate and calls for a physical explanation of the symbol's physical action on the subject matter by the creation of a direct "emotional field" between the experimenters and the subject matter.

If we now broaden our considerations to a general understanding of *matter*, we will end up with the conclusion that while there must be some matter at the origin of all the elementary particles, the matter is also as deep an enigma as is life itself. When we gradually descend the path from the cells, to protoplasm, to amino acids, to the elementary particles and finally to the unfathomed abyss of matter, we hit a "something" that inevitably is at the origin of both the living and of the lifeless world. Such a common origin of the organic and inorganic world so increasingly asserts itself that we are unable to draw a sure boundary between the two worlds. Nor may we, at the same time, establish if the basic elements of matter may already possess, even in a rudimentary degree, the essential properties of life.

The way out of this dilemma requires a new physical approach, which I have been extensively studying. It has yielded encouraging heuristic results to explain the mechanism of action of homeopathic remedies. In that field, my co-workers and I made several blind experiments that have confirmed the inversion of the properties of the active principle and showed a change in the pH of

water samples consequent to the homeopathic treatment. We have recently started experimenting on water samples with resonant passive circuits on a blind procedure.

Claudio Cardella
Dipartimento di Meccanica e Aeronautica
Via Eudossiana 18
00184 Roma
Italia

A Significant Typo and a Corresponding Object Lesson

We wanted to bring the attention of the JSE readership to an important typographic error on our part in the recent article, "A Message in a Bottle: Confounds in Deciphering the Ramey Memo from the Roswell UFO Case" (Houran & Randle, 2002, *JSE*, 16, 45-66). On page 50 of our paper, we relate Russ Estes' opinion of the Ramey memo as, "Estes did say that he could make a 'best guess' about the images on the message. After examining an 8 × 10 enlarged photograph of just the message area via the same techniques and equipment, Estes stated that he perceived the words "Fort Work, Tex" with a limited amount of confidence." (emphasis added). Estes' actual interpretation was, "Fort Worth, Tex." We apologize for the error, which escaped several proof-readings. This just illustrates that not inconsequential errors can creep into translation and transcription efforts—processes inherent to any investigation of the Ramey memo—even by researchers who intend to conduct careful work. Of course if we had sent the proofs of the paper to three, independent laboratories for perusal (akin to our proposed methodology for any future analyses of the memo: pp. 62-63), then perhaps the discrepancy would have been identified sooner!

Sincerely,

James Houran
Southern Illinois University School of Medicine
Dept. of Psychiatry
Springfield, IL
jhouran@siumed.edu

Kevin D. Randle
Cedar Rapids, IA

7. Smith, C. W. (2000, June 8–11). *The diagnosis and therapy of EM hypersensitivity and EM fields in health, in therapies and disease*. Papers presented at the 18th Annual Symposium on Man and His Environment, Dallas, TX.
8. Cardella, C., de Magistris, L., Elia, V., Florio, E., & Niccoli, M. (1998). *Physico-chemical permanent alterations of water induced by an RLC passive circuit*. Paper presented at the 53rd International Homeopathic Medicine League Congress, Amsterdam, the Netherlands.
9. Callegari, G. B. (1969). *Radiobiologia Sperimentale*. Napoli, Italy: Edizioni Famital.
10. Preparata, G. (1995). *QED Coherence in Matter*. Singapore: World Scientific.
11. Arani, R., Bono, I., Del Giudice, E., & Preparata, G. (1995). QED Coherence and the thermodynamics of water. *International Journal of Modern Physics B*, 9, 1813–1841.
12. Del Giudice, E., & Preparata, G. (1994). Coherent dynamics in water as a possible explanation of biological membranes formation. *Journal of Biological Physics*, 20, 105–116.
13. Ludwig, W. (1997). Objektivierung pathognostischer körpereigener Schwingungen. In Endler, P.C. & Stacher, A. (Eds.), *Neiderenergetische Bioinformation*, ges. vol. 17 (pp. 72–82). Vienna: Facultas-Universitätsverlag.
14. Pannaria, F. (1962). *Omeopatia e Fisica nuova*, Ist. di Storia della Medicina dell'Università di Roma. Roma.
15. Cardella, C. (1996, June 15). *The role of water in biological systems, part 2*. Paper presented at the 1st International Workshop on TFF, Turin, Italy.
16. Cardella, C. (1998, April 25–29). *The mirror of homeopathy*. Paper presented at the 53rd Congress of the International Homeopathic Medical League, Amsterdam, the Netherlands.
17. Pannaria, F. (1960). *Il Principio di Scambio nel Cronotopo*, Rend. Acc. dei Lincei, fasc. 5, maggio.
18. Cardella, C., & Di Pascale, F. (1994). The role of water in biological systems. *Accademia*, 1, 6, 12.

Permanent Changes in the Physico-Chemical Properties of Water Following Exposure to Resonant Circuits

CLAUDIO CARDELLA

*University of Rome, "La Sapienza," Italy;
A.R.T.I. Research Team, Napoli, Italy*

LAURA DE MAGISTRIS

*2nd University of Naples, Italy;
A.R.T.I. Research Team, Napoli, Italy*

ETTORE FLORIO

A.R.T.I. Research Team, Napoli, Italy

CYRIL W. SMITH

Salford University, UK

Abstract—The aim of this study is to present the results of three years of experimental work on the interaction of water samples with passive resonant circuits. We shall finally attempt a physical justification for the changes that are produced in the water sample.

Permanent changes in the physico-chemical properties of a water sample were obtained by exposing it to a very simple device based on an RCL passive resonator. We detected these changes by means of a microcalorimetric (heat-of-mixing) procedure that had previously been applied to homeopathic solutions. Most experiments (60 samples) showed an exothermic heat excess relative to the reference water. All the microcalorimetric titration curves from these measurements on the treated water samples looked alike from a qualitative point of view and all of them displayed a break point at the same test solution concentration. We performed pH measurements during about half the total number of tests and observed an increase of the pH value (i.e., toward basic) in all but three of the exposed samples.

Keywords: Water — physico-chemical changes — passive circuit — radionics.

Introduction

Hardly any experimental procedure is available for detecting the physico-chemical changes that homeopathic succussion or other similar techniques can produce in water. Recently, a thermodynamic procedure was developed and proved effective in characterizing homeopathic remedies^[1,2]. It consists in the comparison of the heat-of-mixing reaction of acids or bases in various concentrations with extremely diluted solutions and with bi-distilled water as the

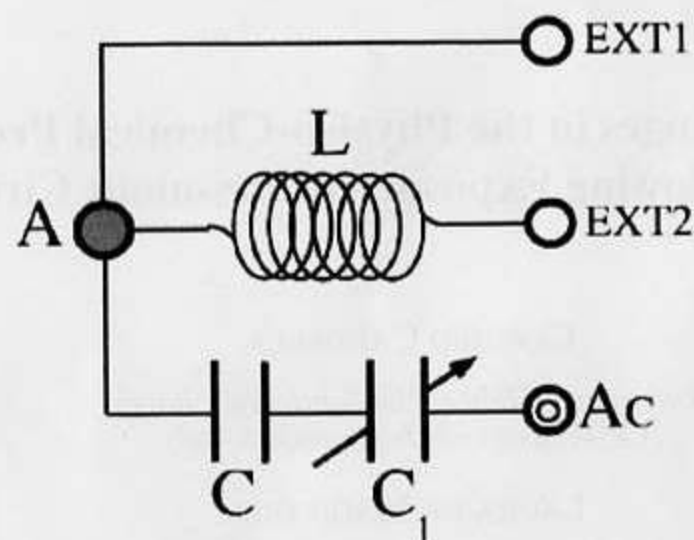

RLC passive oscillator

Fig. 1. Modified Callegari Radionic Circuit.

control. In 100% of the cases, the homeopathically treated solutions showed a heat excess with respect to the control water.

We based our early observations on the effects of ultra-low electromagnetic fields^[3] mainly on the Sensitive Crystallization Method and on biological tests. Incidentally, these hinted at the existence of a possible relationship between homeopathy and ultra-low electromagnetic fields. The biological effects of weak electromagnetic fields have been investigated by C.W. Smith since 1974^[4]. Recently, he established equivalence between specific electromagnetic frequencies and homeopathic remedies and acupuncture meridians^[5,6,7].

Material & Methods

The Apparatus

We standardized on a common experimental procedure and used the same exposure device in all the tests we performed. Three different resonant circuits were used with this device for exposing the water samples.

The Exposure Device

This couples the electromagnetic field from the resonator to the water sample so that the water only comes into physical contact with a glass beaker and never with the device itself. The device is composed of two elements, i.e., an external brass ring (diameter $\phi = 24$ mm, 10 mm high, 1 mm thick) and an internal concentric copper dish (diameter $\phi = 12$ mm) with curvature corresponding to one third of a 10 mm radius sphere. An insulating plastic ring is interposed between the two above elements. Thus, they are kept electrically separated from each other while independently connected to the resonator through insulated copper wires connected in turn to the plugs/sockets **EXT1** and **EXT2** as shown in the Figures 1, 2 and 3.

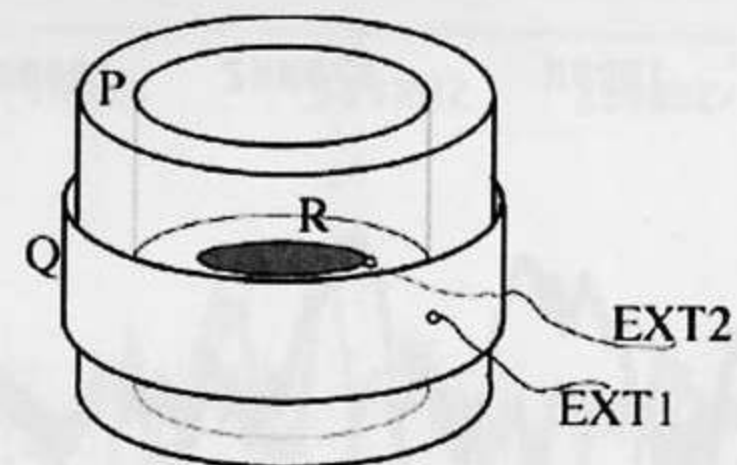

Fig. 2. Water Exposure Device.

The Passive RLC Circuits

The first resonator circuit we used to irradiate water samples was a modified Callegari Radionic Circuit^[8], and its diagram is shown in Figure 1.

Figure 2 shows the essential features of the Water Exposure Device (*R* indicates the internal copper disk, *Q* the external brass ring and *P* the plastic ring).

We later developed and used two other circuits that were quite similar to each other. Their conception and design are substantially different from the first device (Figure 1) as the diagram in Figure 3 clearly shows. Although the component elements and the electrical parameters are the same as those in the previous diagram, a ferrite bar has been added. The set-up and the electrical parameters are fully described in the previous references^[3,8], but for the sake of clarity, we briefly repeat them here. The aerial, *A*, is a brass sphere with diameter $\phi = 5.5$ mm having a capacitance $C = 900$ pF; *C1* is a variable 30–300 pF capacitor; the inductance of $L = 0.02$ H. **EXT1** and **EXT2** refer to the sockets on the resonator in Figure 1 and the corresponding plugs in Figure 2 on the ex-

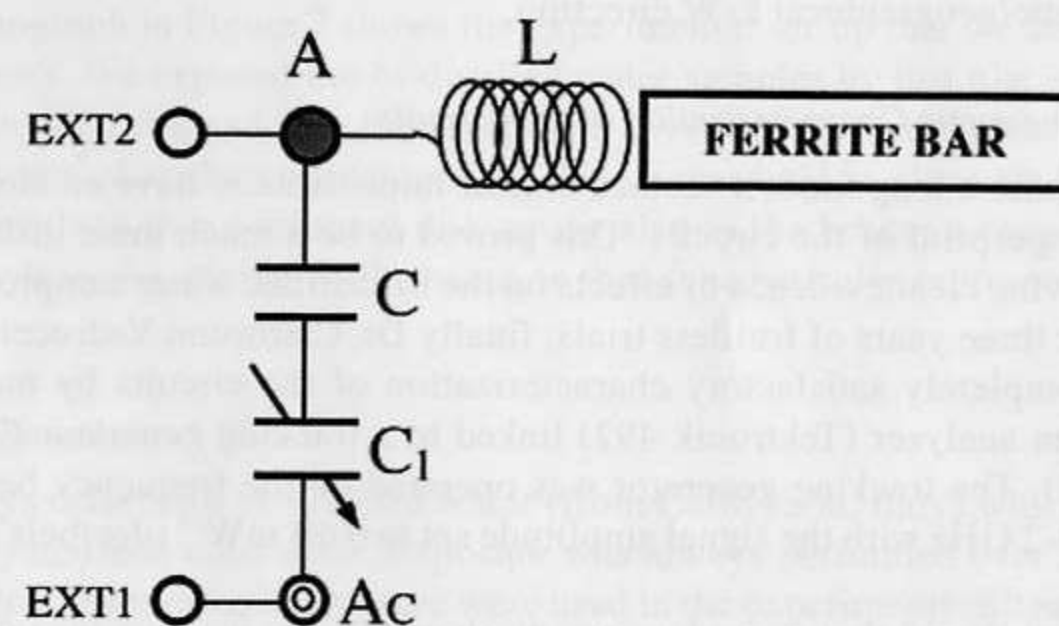

Fig. 3. The ferrite circuit.

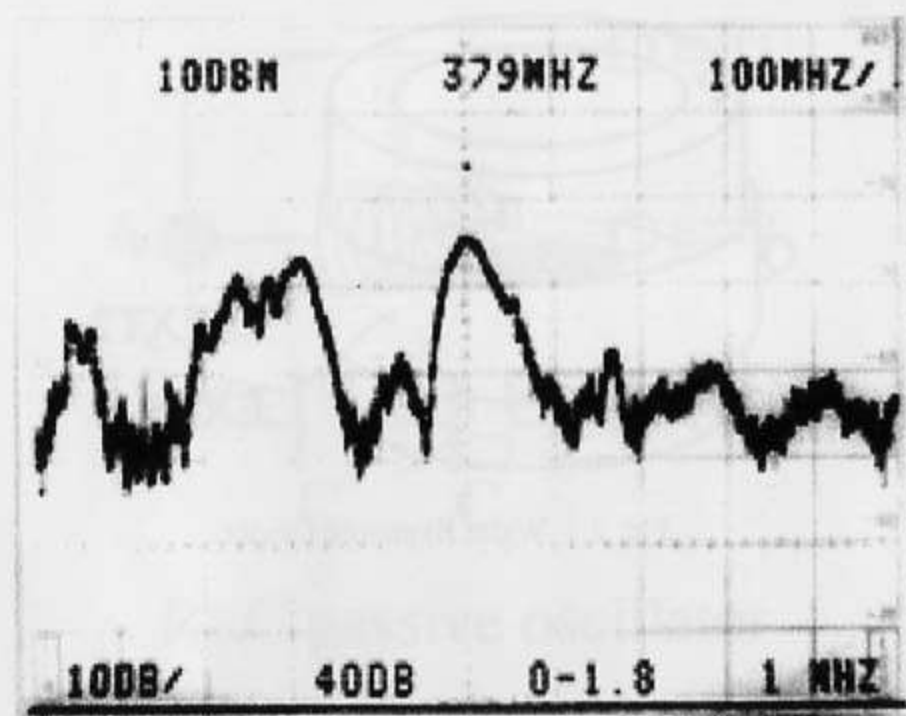

Fig. 4. Resonance spectrum of the circuit shown in Figure 1.

posure device. Finally, **Ac** is an unused socket serving as an elementary aerial compensating device.

Methods for Using the Apparatus

We exposed the bi-distilled water samples contained in glass vials or beakers by placing them under the exposure device. The resonator was connected to the above-mentioned exposure device. In all the circuits, one of the plugs is always located at the end opposite to the inductance (**EXT2**) and in line with the aerial (terminal **Ac**). It is important to note that the whole apparatus has no connection to any external or internal electric supply, or to a generator, or to any other source of energy or oscillations. It is completely passive. The inductance axis in the operating condition must lie parallel to the local geomagnetic/geographical E-W direction.

Electromagnetic Characterization of the Circuits

For quite a long time, it seemed almost impossible to have an electromagnetic fingerprint of the circuits. This proved to be a much more difficult task than having clear evidence of effects on the bi-distilled water samples.

After three years of fruitless trials, finally Dr. Clarbruno Vedruccio provided a completely satisfactory characterization of the circuits by means of a spectrum analyzer (Tektronik 492) linked to a tracking generator (Tektronik TR 504). The tracking generator was operated on the frequency band in the range 0–2 GHz with the signal amplitude set to 0 dB mW⁻¹ (decibels per milliwatt).¹

The results of that procedure are displayed in the pictures taken from the spectrum analyser (Figures 4 and 5) when the absorption spectra of the circuits

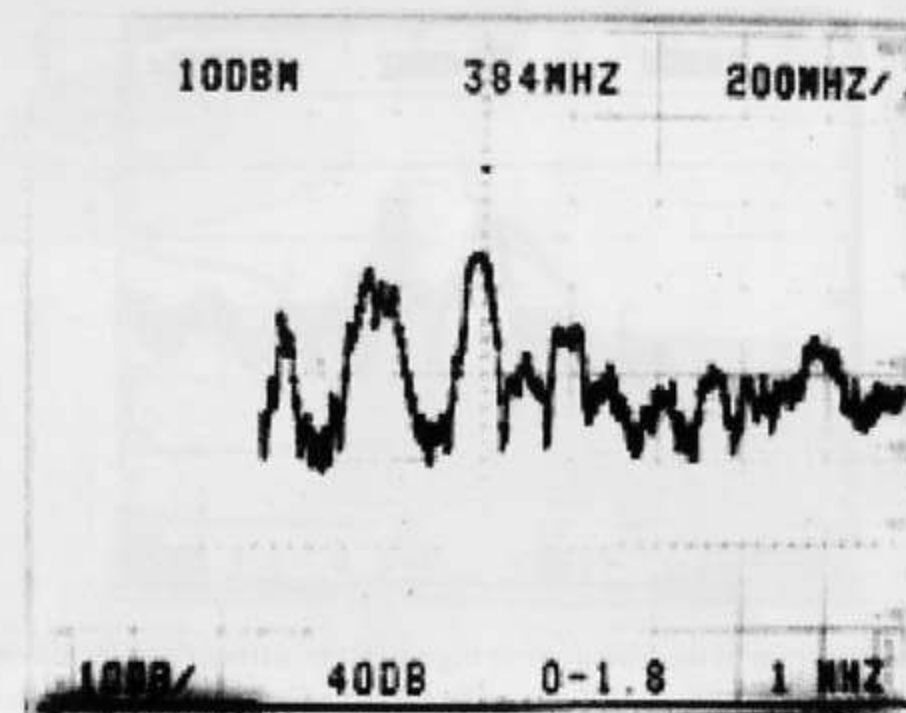

Fig. 5. Resonance spectrum of the circuit shown in Figure 3.

were being displayed. Figure 4 refers to the circuit shown in the diagram in Figure 1, while Figure 5 refers to the circuit shown in Figure 3.

It is a quite remarkable event that albeit the circuit designs are very different from each other, both exhibit very similar shapes. The very close values of the frequencies corresponding to the main absorption peaks are located at 379 MHz and 384 MHz. The left-side secondary absorption peak in Figure 5 can be reasonably interpreted as the fingerprint of the exposure device. In fact, that peak does not appear when the irradiating device is not plugged in the circuit. This is confirmed by the following picture, Figure 6, which refers to the same circuit as that analyzed in Figure 5.

The Experimental Set-up

The photograph in Figure 7 shows the experimental set-up that we adopted in all our tests. We exposed the bi-distilled water samples by just placing the exposure device (plugged into the resonator) over the top of the clear glass beaker that served as their container. The device was held in place above the water surface by a thin cardboard disk acting also as the beaker's cover. The circuit shown in this picture is the same as that schematically represented in Figure 2.

Sample Preparation

We always used fresh bi-distilled water (from Carlo Erba, Italy) which was kept in polyethylene until used. Exposure was always performed over Pyrex glass beakers. Several water volumes were used in the experiments: 80 ml, 100 ml, 250 ml or 400 ml.

Two different irradiation times were tested in general: 6 hours or 24 hours.

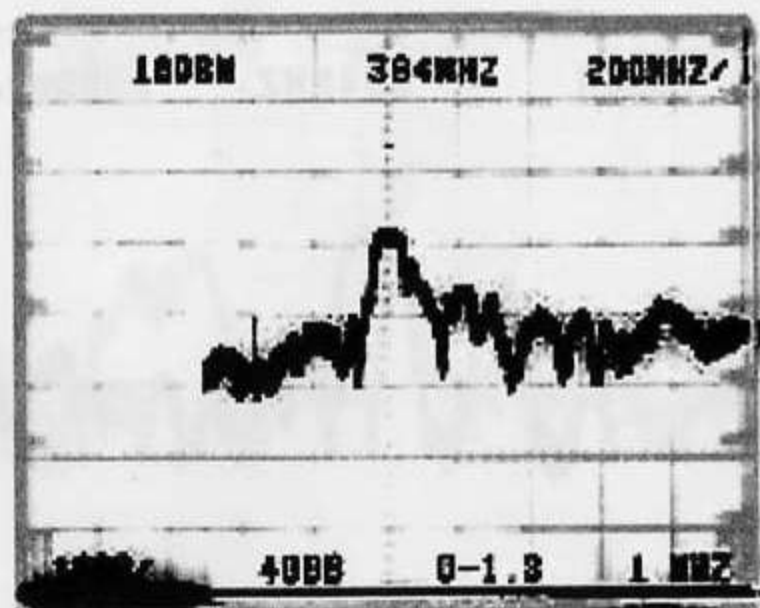

Fig. 6. Resonance spectrum of the circuit as in Figure 3, but without connection to the exposure device.

In two experiments, from an initial 250 ml water sample, 20 ml aliquots were taken after 1, 2, 3, 4, 5 and 6 hours, and then the residual volume was left exposed for up to 24 hours.

Once the exposure time had elapsed, the samples were always transferred into dark glass bottles. In all experiments, a control comprising the same volume of the same non-exposed bi-distilled water was kept in the same kind of dark glass bottles. The bottles containing the samples were kept far apart from the controls until measured. Both calorimetric and pH-metric measurements were performed. These were carried out at various times after the sample production ranging from a few hours to 14 days in order to determine the stability of the effects over time.

Microcalorimetric Apparatus

We measured the heats of mixing by means of a Thermal Activity Monitor (TAM) from Thermometric (Sweden) with $0.1 \mu\text{W}$ sensitivity. It is equipped with flow-mixing and a batch titration vessel. In the case of the flow-mixing vessel, two peristaltic pumps convey solutions into the calorimeter through Teflon tubes. The flow rates through the inlet pipes are equal and constant, so that the solution coming out of the calorimeter has a concentration one half of the initial concentration. Our mass flow rate was constant to within 1% and its value $P_w = 3 \times 10^{-3} \text{ g s}^{-1}$ remained the same in all the experiments. The following relation defines the enthalpies of mixing ΔH_{mix} :

$$\Delta H_{\text{mix}}(m_x^i \rightarrow m_x^f) = -(dQ/dt)P_w,$$

where (dQ/dt) is the heat flux s^{-1} (Watt), P_w is the total mass flow rate of the solvent (kg s^{-1}) and m_x^i and m_x^f are the initial and final molalities, respectively, of the solution. ΔH_{mix} is expressed in J kg^{-1} of solvent.

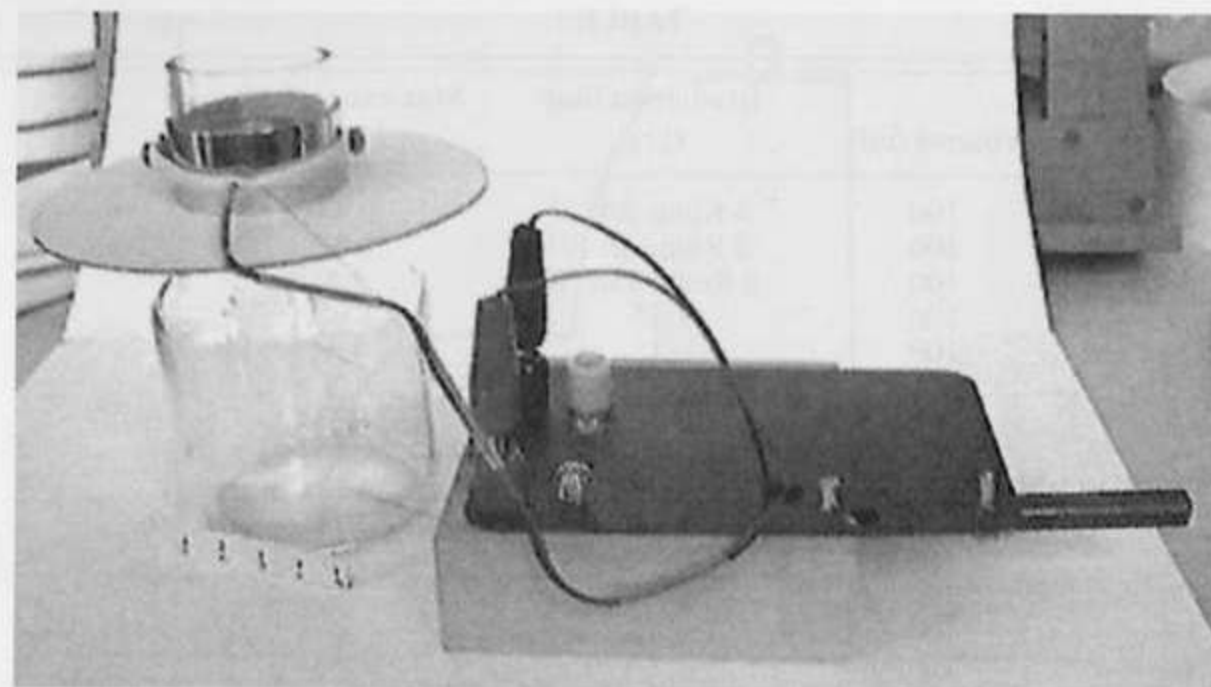

Fig. 7. Exposure device placed over a beaker of bi-distilled water showing connections to the resonator circuit.

Calorimetric Measurement Procedures

The authors are indebted to Prof. Vittorio Elia and Dr. Marcella Niccoli of the University of Naples for these microcalorimetric measurements and procedures. The main experimenters were the co-authors Laura de Magistris and Ettore Florio who did the experimental procedures of water specimen exposure. However, six of the sample exposures were done by Claudio Cardella acting as an independent experimenter and these are indicated by "Rome" in Table 1.

We matched each calorimetric test with a test on the pure bi-distilled water control. For this purpose, we compared every enthalpy measurement obtained by mixing a sample of irradiated water with test solution (an acid or a basic solution), with the measurement obtained by mixing pure water with the same test solution under the same experimental conditions.

Figure 8 shows the measuring procedure through a typical power versus time diagram that results from a single calorimetric measurement. Line A represents the solvent water steady state condition: only pure water enters the calorimeter through both the input tubes. In this case, the heat produced is from the mixing of two solutions having identical concentrations, specifically bi-distilled water mixing with bi-distilled water, is evidently zero. Thus, we take line A as the base line. Bi-distilled water mixing with an acid or with a basic solution at a certain concentration yields line B once the system has reached a steady state. Line C refers to the steady states reached by mixing Device Exposed Water with an acid or a basic solution at the same concentration. There is a value increase as shown, this we read on the ordinate axis between stationary states C and B. It is proportional to the excess heat of mixing for the exposed water relative to the reference water. Finally, line D is again a base line and refers to the same experimental conditions as those yielding line A, i.e., reference water against reference water.

TABLE I

Sample number	Volume (ml)	Irradiation time (hrs)	Max excess heat (J kg ⁻¹)	ΔpH
A	100	8 Rome 2/6/97	0.42	
B	100	8 Rome 1/6/97	1.87	
0	100	8 Rome 13/6/97	3.6	
1	100	15	1.95	
1b	100	15	4.5	
2	100	15	1.8	
3	100	15	1.73	
4	100	15	1.25	
5	100	72	1.12	
6	100	15	0.71	
7	100	72	1.6	
8	100	15	4.4	
9	100	15	1	
10	100	15	1.54	
11	100	15	1.4	
12	100	15	0.8	
13	100	6 Rome 26/6/97	1.6	
14	100	6 Rome 6/7/97	0.96	
15	100	6 Rome 7/7/97	0.35	
16	100	6	0	
17	250	1-24	5.5	
18	250	1-24	6.2	
19	400	24	5	
20	400	24	0	
21	400	24	0	0.01
22	80	6	2.7	1.4
23	80	6	3.6	2.6
24	80	6	0.3	0.3
25	80	24	0.3	0.2
26	80	6	0	0.3
27	80	25	0.05	2.5
28	80	24	3.4	1.2
29	80	24	0	
30	80	24	0	
31	80	22	0.3	0.3
32	80	24	0.7	0.45
33	80	24	negative	0.01
34	80	24	negative	0.2
35	80	24	negative	0.2
36	110	24	negative	0.025
37	110	24	negative	0.075
38	110	6	negative	-0.4
39	110	24	negative	-0.2
40	110	24	0	-0.3
41	110	24	0	0.1
42	110	24 phys. saline	Ind.	0.01
43	110	24 phys. saline	Ind.	0.005
44	110	24	negative	0.1
45	110	24	negative	0.1
46	250	24	0	0.09
47	250	24	0.19	0.2
48	250	24	0	0.3
49	250	Ref.	0	
50	250	24	0	0.2
51	250	24	0	0.5
52	250	Ref.	4.1	
53	250	24	-0.2	-0.1
54	250	24	-0.6	-1

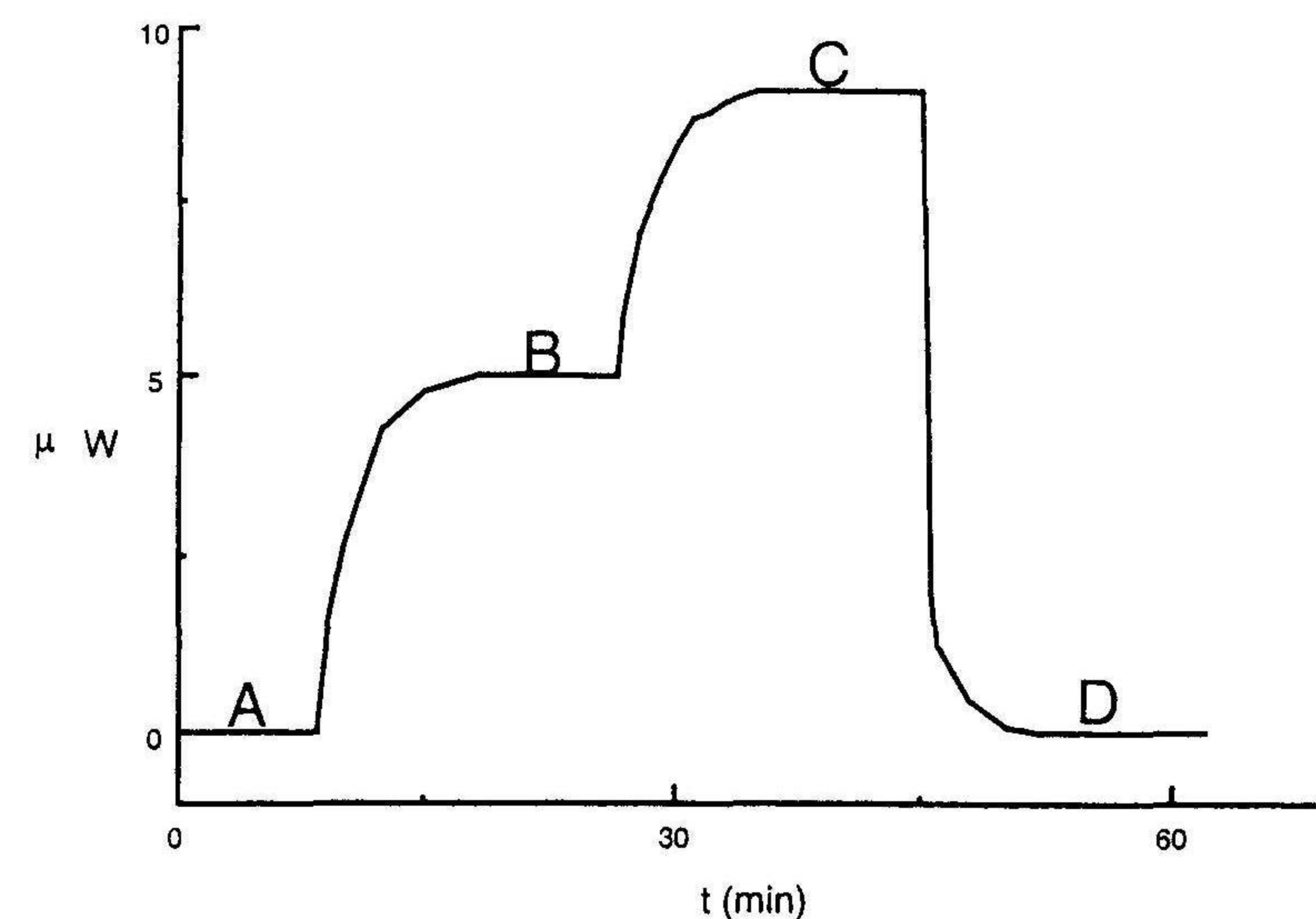

Fig. 8. Power versus time diagram. A is the solvent water steady state condition. B is the enthalpy steady state value reached by mixing bi-distilled water with an acid or a basic solution. C is the steady state value reached by mixing an exposed sample with the same acid or base in the same experimental conditions.

We performed about 150 heat-of-mixing measurements using NaOH or HCl as the test solutions at various concentrations in the 0–0.01 mol kg⁻¹ range. All the microcalorimetric tests showed the line C ordinate higher than the line B ordinate. Thus, in all cases we observed an excess of exothermic heat of mixing with the Device Exposed Water.

Figure 9 shows two typical experimental diagrams that display the excess heat of mixing of a Device Exposed Water sample versus the concentration of two different test solutions. In other words it refers to the same water sample and shows the two graphs for microcalorimetric titrations against NaOH and HCl. Thus, Figure 9 provides more complete information about the changes that the exposure procedure induces in the water. Namely, Figure 9 displays the excess heat of mixing (in J kg⁻¹) resulting from the addition of test solutions with increasing concentration m (in mol kg⁻¹) to device exposed and to reference water samples. The test solutions we used were NaOH (in graph I) and HCl (in graph II) solutions. The exposed water sample was exposed for about 13 hours by means of the apparatus described above.

Curve I in Figure 9 shows that any increase in NaOH concentration yields a substantial excess heat increase only up to the “break point” located at 1×10^{-3} m concentration. Further concentration increases yield only small variations in the excess heat until a constant value is reached.

When instead HCl is used as the test solution, the excess heat is found independent of the HCl concentration (graph II).

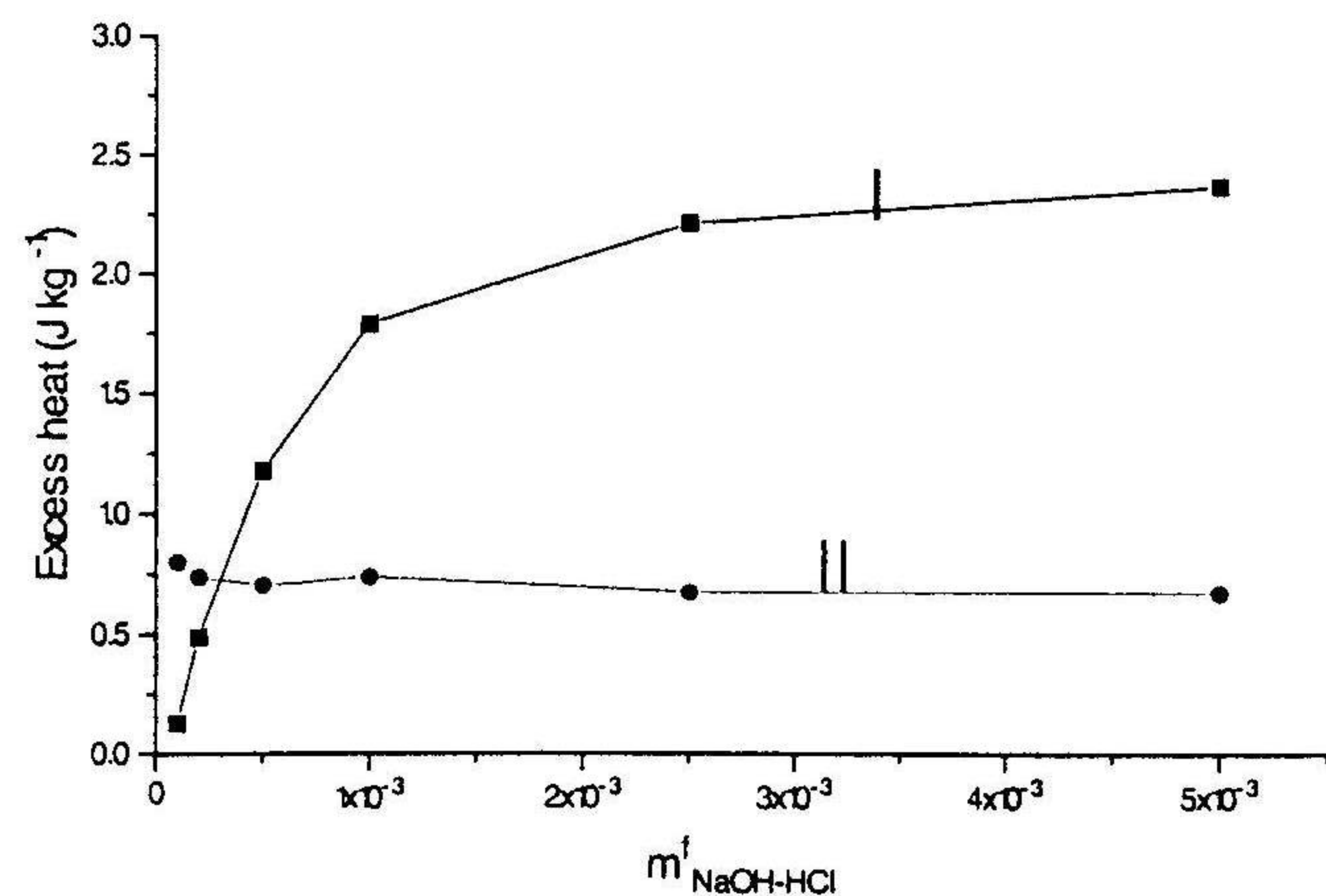

Fig. 9. Graph I: calorimetric titration by NaOH. Graph II: calorimetric titration by HCl.

Results

Microcalorimetric Measurements

We exposed 60 water samples by means of the RCL passive circuit. All of them underwent microcalorimetric titration by NaOH test solutions; 10 of them also underwent titration by HCl test solutions. All of them showed an excess (exothermic) heat of mixing in titration with both NaOH and HCl test solutions.

To compare results from the various experiments, each calorimetric measure was expressed as the maximal excess heat obtained by mixing with NaOH when the control's value of heat of mixing was subtracted. The excess heat is expressed as J kg^{-1} and the maximum values are listed in Table 1, which summarizes all the experiments.

In 31 of the 60 samples, an excess heat was measured. Its values ranged from 0.19 J kg^{-1} to 6.2 J kg^{-1} ; the median value being 1.87 J kg^{-1} . In 18 samples, no significant excess heat was detected, its value being close to that measured in the control samples. In the remaining 11 samples we observed an excess heat value significantly lower than that of the corresponding control, these measured negative values ranging between 0.2 and 2.0 J kg^{-1} . These negative values were most likely produced by an alteration of the geo-magnetic field that actually took place at the time the measurements were performed due to an exceptional solar magnetic activity. This should have changed the Schumann Band radiation in which one resonance is at 7.8 Hz , which is the low frequency coherence corresponding to the 384 MHz of the RLC circuits used in these experiments. Since we did not know of this event until recently, we reported these cases in Table 1 under the generic heading of a "negative" value.

It is worth noting that all the NaOH titration curves exhibit a common fea-

TABLE 2
Experiments Where Hourly Quotas Were Taken (Excess Heat Expressed as J kg^{-1})

Sample number		1 hr	2 hr	3 hr	4 hr	5 hr	6 hr	24 hr
1	ΔH_{mix}	0	0	0	0	0.5	0	5.5
2	ΔH_{mix}	0	0	0	0	0.45	0.45	6.2

ture. Namely, that in all cases the excess heat-of-mixing diagram shows a break point (i.e., it flattens out) at the same NaOH concentration value. This constant value is $1 \times 10^{-3} m$ regardless of the upper value of the excess heat of mixing that actually ranged between 1 and 4 J kg^{-1} . Conversely, all the HCl titration curves showed a mutually similar behavior in that they all had an approximately constant excess heat of mixing of value 0.64 J kg^{-1} .

In two samples, hourly aliquots were taken and these results are reported in Table 2. A significant excess heat appeared only after a 4 hour exposure, it then increased until a maximum value was reached after 24 hours. Upon comparison of the results obtained with 6 and with 24 hours exposure time, we can easily see that the longer exposure time does not appear to affect the result significantly (see Table 1). This fact hints at the existence of a saturation exposure time, which is reached between 4 and 6 hours. Similarly, the volume of the sample exposed was always at least in the 80–400 ml range and seems to be independent of the measured heat excess values.

In four cases, we repeated the measurements on the same water samples again after about 20 days and we always observed an increase in the heat excess, this could be up to twice the preceding value.

After about a further 20 days, we performed for a second time the previous measurements on the same samples. We obtained titration curves similar to the earlier ones, and again the same concentration value of $1 \times 10^{-3} m$ at the break point characterized all the NaOH curves. This event was verified in spite of the remarkable fact that the maximum value of excess heat had increased up to twice the previous value in all the observed cases.

pH Measurements

We performed pH measurements on 29 out of the 60 samples. The apparatus we used was equipped with an electrode for low molecular force solutions. The values that we measured on irradiated water samples were compared to their corresponding controls, and the results were expressed as a ΔpH increase. The generally observed pattern in these measurements was an increase toward basic pH values as shown by the ΔpH changes reported in Table 2. The ΔpH values ranged between 0.05 and 2.60 pH units; in five cases, the ΔpH change shifted toward acid values, and these are indicated in Table 1 as negative values. All the negative ΔpH values corresponded to negative or zero excess heats, but there were positive ΔpH changes with negative excess heats.

Conclusion and Discussion

From the above considerations, we feel able to draw the following conclusions:

(a) Exposure of bi-distilled water samples to a passive resonant circuit by the above-described procedures does affect water samples in a "permanent" way.² At present, this means that the observed changes persist over a relatively long time interval, a month or more.

(b) The effects of the changes produced in the water samples in this way can be detected and evaluated by both microcalorimetric and by pH measurements.

(c) The experimental results can be repeated and checked repeatedly. However, they do not seem to be **exactly** reproducible. This means that although we have clear evidence of the fact that the above effects occur over repeated experiments, we have not yet found an experimental procedure leading to precisely the same measured values each time.

(d) The effects of this exposure on water can be enhanced by mechanical or thermal treatments. For example, water samples that had been previously shocked (succussed) mechanically or dynamised (potentized) gave higher values of ΔH_{mix} than ones not so treated. The same applies to thermal treatment. When we measured an irradiated water sample after boiling it for 20 minutes in oxygen controlled atmosphere, we got higher values of ΔH_{mix} .

(e) The ferrite circuits proved to be much more effective than the Callegari-like ones. The measured values from the effects of ferrite circuits ranged from 3 to 5 times higher than those obtained by Callegari-like circuits.

(f) There is a definite influence of the inverse time arrow on the irradiated water samples. When the measurements on a same irradiated water sample were repeated after a certain time interval, an increase in the measured values was found. Thus, we feel able to state that such an increase has grown during time subsequent to the irradiation, at least for a certain period which can roughly be evaluated as 3 or 4 weeks.

Discussion of mechanism of action

There has been a considerable amount of serendipity in the development of this work throughout the past three years. This is a necessary premise to the following considerations, since one may ask how all this study started and where the idea of operating with passive circuits originated. The first input was the lecture on G.B. Callegari's work^[9] about his simple experiments with radionic passive circuits. Subsequently, we verified that the circuits he described actually produced observable effects on matter, albeit effects very hard to measure due to their extremely low intensity. The great difficulty in obtaining some experimental evidence with the Callegari circuits led to the development of the first circuit previously described herein and to the exposure of water using it, in the hope of a better chance of getting measurable effects. Fi-

nally, the microcalorimetric method of Prof. V. Elia gave us the chance to measure the changes that this produced in water. Evaluation of these effects allowed us to develop a second kind of circuit (Figure 3) that proved to be much more effective than the first one (Figure 1).

In conclusion, the progress of this study was rather empirical and was powered by sheer curiosity. That is to say, it was impossible for us to find an adequate theoretical explanation for these findings. Nonetheless, some attempts in that direction seemed justified, hence this paper.

It is undeniable that the effects of water irradiation by the passive circuits are measurable by an objective physical method, whereas their physical cause is hardly detectable. In fact, while there is a measurable energy output, no energy input can be traced, only information has been supplied to the water.

As a first viable hypothesis, we considered that the RLC resonant circuits could act as amplifiers of some very low intensity electromagnetic field frequencies that occur in the water. Our second hypothesis was that they were very specific frequency converters and amplifiers of the local geo-magnetic field fluctuations.

It may be worthwhile to focus attention on the last feature (f) mentioned in the previous section, as this is quite difficult to explain by any physico-chemical approach. Namely, the time behavior of the irradiated water sample seems to resemble more that of a living organism than that of so-called inorganic matter. The problem here is very much like that presented by certain viruses. It is well known that some viruses can be crystallized like inorganic molecules and that they can actually comprise just a single molecule about the size of a sucrose molecule. If now we attempted to interpret the behavior of these viruses based on their chemical formulae, their vital behavior would become mysterious or even incomprehensible.

Thermal Effects on Water

In paragraph (d) above, we remarked that when we measured an irradiated water sample after boiling it for 20 minutes in an oxygen-controlled atmosphere we got higher values of ΔH_{mix} . Following EU regulations, homoeopathic preparations are now heated to 90°C. This has the effect of making a potency come out lower than that given on the label. For example, D10 comes out as D6. The original potency can be restored by succussion but no one tells the patients to do this.

To simulate a potency in an easily measurable way, the frequency 1 kHz was imprinted into water. At 70°C, there was a change accompanied by the appearance of additional resonances at 100 Hz and 10 kHz. Succussing a tube heated between 70°C and 90°C recovered the original 'stimulatory' imprint at 1 kHz while the resonances at 100 Hz and 10 kHz disappeared. From 90°C to boiling point, there was yet another change, no resonance was found at 1 kHz, but the original 1 kHz imprint could be recovered by succussing in the presence of 384 MHz, 1.42 GHz or 2.65 GHz. The frequency 1.42 GHz corresponds to the 21-

cm wavelength resonance of molecular hydrogen. When heated in a glass vessel within a pressure cooker to 121°C for 3 minutes and allowed to cool, an aliquot at 1 kHz gave no response. In the presence of 2.65 GHz, 1.42 GHz or 384 MHz there was a minimal response, but succussion in the presence of any of these frequencies gave a restored 1 kHz resonance.

The frequencies 2.65 GHz, 1.42 GHz and 384 MHz have further unexpected properties. If water imprinted at 1 kHz is succussed under appropriate conditions in the presence of the above frequencies at ambient temperature, the 1 kHz can become "hidden". This 1 kHz is recoverable by succussion. The frequency 384 MHz is the high frequency branch of the heart meridian and heart chakra endogenous frequency, the lower branch is at 7.8 Hz which has similar properties.

In all the above cases, placing aliquots in a closed steel box at ambient temperature resulted in the erasure of the frequency imprint. This erasure seemed permanent and an imprint thus erased could not be recovered by any method of affecting frequency imprints found so far.

A dilute solution of a chemical (e.g., NaCl at 6 mM) can have its chemical frequency signature "hidden" by succussion at 2.65 GHz, 1.42 GHz or 384 MHz. This too is recoverable by succussion at 7.8 Hz or placing near the heart chakra. Placing this solution in a closed steel box does not erase its chemical signature whether "hidden" or manifest. The "hiding" of a chemical signature only in dilute solution suggests that the molecules of the chemical may have become enclosed within a limited concentration of coherence domains, thereby gaining protection from external excitation.

The erasure of imprints in a closed steel box points to the same basic physical process for "Water Memory"³ and the fact that the geomagnetic field must be necessary for frequency imprint retention over the whole temperature range investigated. Also, there must be at least three memory structures. One is stimulated by a toroid below 70°C, another is stimulated by a solenoid from 90°C to boiling point and a third is stimulated by a Caduceus coil and persists from boiling point to at least 121°C.

Theory of Water

To understand the physics of interactions of frequencies with water and biological systems, it is necessary to consider the quantum-electro-dynamic (QED) coherence aspects of the problem. Preparata^[10] has investigated this problem theoretically for *condensed matter* (anything not a gas) in general and with co-workers has more specifically addressed the theory of water^[11] and biological systems^[12]. The important conclusion is that water and water containing systems have *coherence* as a fundamental property present in their ground energy states; no "pumping" is required to achieve this coherence as must be done for a laser. In water, a perfect coherence is calculated to occur within domains 75 nm in size. Within these domains, all water molecules oscillate coherently with a classical electromagnetic field at a frequency in the ultra-violet

part of the spectrum of water (12.06 eV). This provides a highly coherent carrier frequency upon which further lower frequency coherent oscillations can be modulated. Interaction between domains of coherence gives rise to a long-range order, which propagates at the velocity of light and at a velocity of a few meters per second.

It is the coherent water that has the "memory" properties. The incoherent water is responsible for the normal thermodynamic properties of water including the heat of mixing. This theory is the only one to give the correct latent heat of evaporation and the correct dielectric constant for water and to account for its anomalous behaviour.

External radiation will interact with an entire coherence domain, not with individual molecules. Within a coherent system, the coherence length is the constant parameter and there can be many interacting velocities and proportional frequencies.

These coherent oscillations only weakly couple to external electromagnetic fields so that their measurement with conventional instrumentation is difficult. Living systems can make use of these coherent oscillations through the wave equations describing their quantum states. The magnetic vector potential (**A**) enters into these equations as a chemical potential would.

These oscillations have been measured with objective instrumentation in water and human subjects^[6,13] but only over a limited range of frequencies. C.W. Smith developed a subjective method^[6] that uses the high sensitivity of the body to the fields of electrical oscillators to measure coherence frequencies in water and living systems from Millihertz to Gigahertz. Most chemical substances have one or more coherent frequencies (i.e., chemical signatures) associated with them. These probably originate from hydrogen-bonding to traces of water usually present.

As early as 1962, Francesco Pannaria gave an important contribution to the theory of water in a study about the mechanism of action of homeopathy^[14] that later was further investigated by C. Cardella^[15,16]. The theory is based on the matter-antimatter equilibrium, which in Pannaria's view is quite different from Dirac's conception and is governed by the *Exchange Principle*^[17]. Specifically, this controls the interaction between the energy state of water as we usually conceive it and its "background energy", i.e., the energy pertaining to water's sub-quantum medium (De Broglie's "*milieu subquantique*"). The changes in background energy have an ordering effect that finally leads to the structural arrangement responsible for water memory^[18].

Resonator Coupled to Water—Possible Mechanisms

Effects without power transmission are not novel, one only has to think of Volt-Amps-Reactive in electrical power systems. The 384 MHz resonator is one of two coupled circuits at the same resonant frequency, the other being an internal resonance in the water. There will be a condition, related to their *Q*'s, for maximum power transfer between them. It is only necessary to postulate